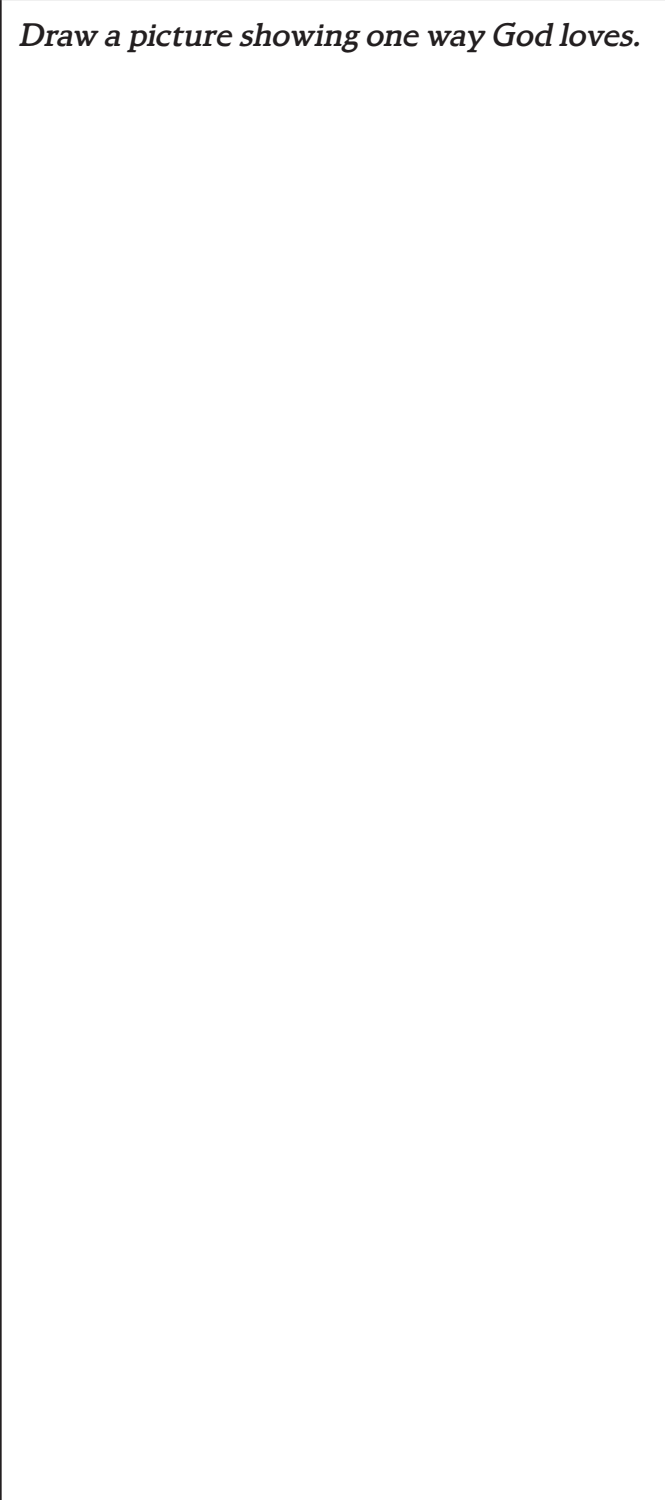
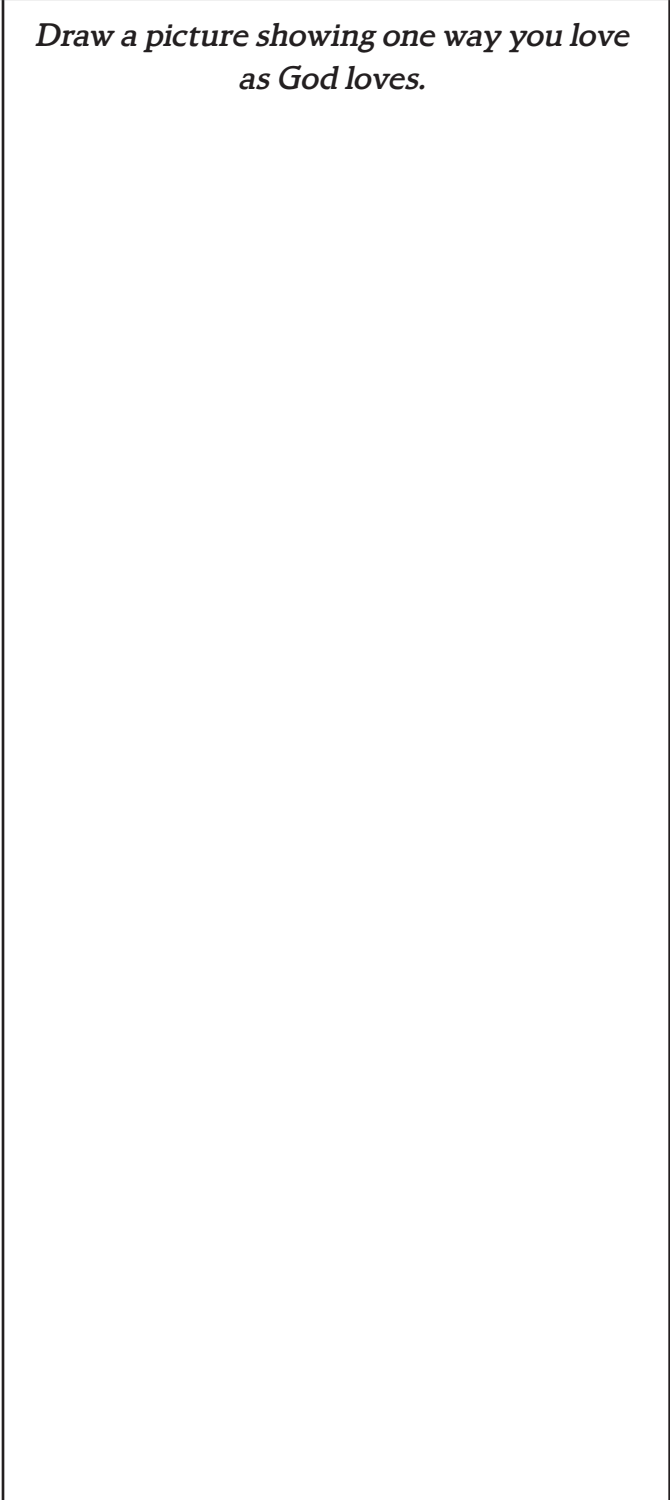

ACTIVITY SHEET 1:
GOD LOVES, I LOVE

Name: _____

GOD LOVES	I LOVE
<p><i>Draw a picture showing one way God loves.</i></p> 	<p><i>Draw a picture showing one way you love as God loves.</i></p> 

ACTIVITY SHEET 2:
1 or 3?

Name: _____

Fill in the Blanks with a "1" or a "3".

1. Here is _____ family.

2. In this family there are _____ persons.

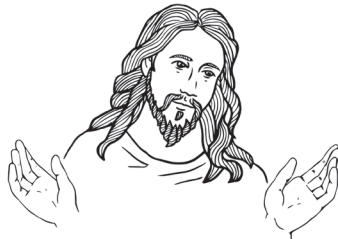

3. Here is Jesus. He is _____ of the Persons of the Blessed Trinity.



4. There are _____ Persons in the Blessed Trinity.

5. The _____ st Person of the Holy Trinity is the Father.

6. The _____ rd Person of the Blessed Trinity is the Holy Spirit.

7. There is only _____ God.

ACTIVITY SHEET 3:
Creation

Name: _____

<i>Draw in the boxes one or more of the things God made on each day of creation.</i>		
Day 1	Day 2	Day 3
Day 4	Day 5	Day 6

What did God do on the 7th day? _____

ACTIVITY SHEET 4A: Adam and Eve Cut-outs

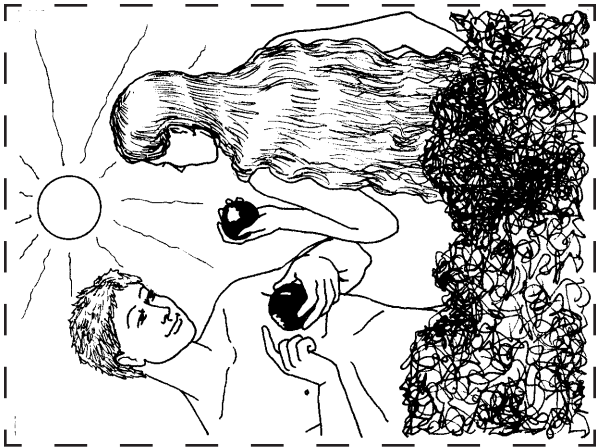
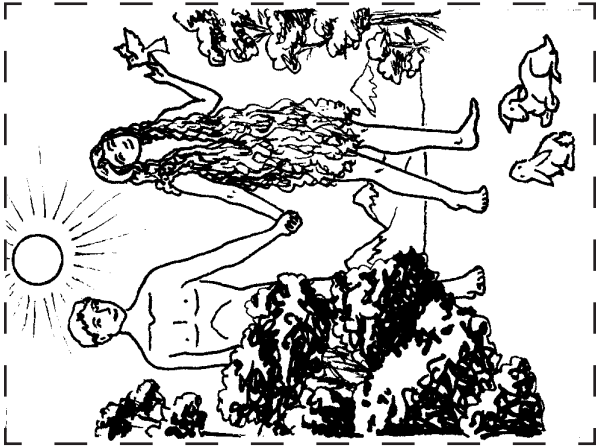

ACTIVITY SHEET 4B: **The Fall**

Name: _____

--	--	--

1. At first, Adam and Eve were happy in the Garden of Eden.

2. But then Satan tempted Eve.

3. Adam and Eve disobeyed God. This was the Original Sin.

--	--	--

4. Adam and Eve were ashamed. They hid from God.

5. God knew what they had done. He said sad things would happen. But he also promised a Savior.

6. Adam and Eve had to leave the Garden of Eden.

ACTIVITY SHEET 5: The Covenant with Abraham

Name: _____

Long ago in a  called Ur lived a  named Abram.

One day God spoke to him. He said, “I want you to move—you and your whole

 —to another . I will make a new nation there.

It will be a great nation, and the whole  will be better because of it.”

Abram left his  with his whole . The trip took a

long time. On the way, God spoke to him again. God changed his name to Abraham,

which means “father of many nations.” God promised Abraham that he would have so

many , grandchildren, and great-grandchildren, that they would

“number as the .

Abraham finally reached this new . He became the founder of

the nation of Israel. This is the very nation from which  came!

It is through  that the whole  is blessed.

God kept his promise to Abraham.

ACTIVITY SHEET 6: The First Passover

Name: _____

*Draw on the table three of the things the Hebrews ate at the Passover meal.
Also show how they marked their doorway.*

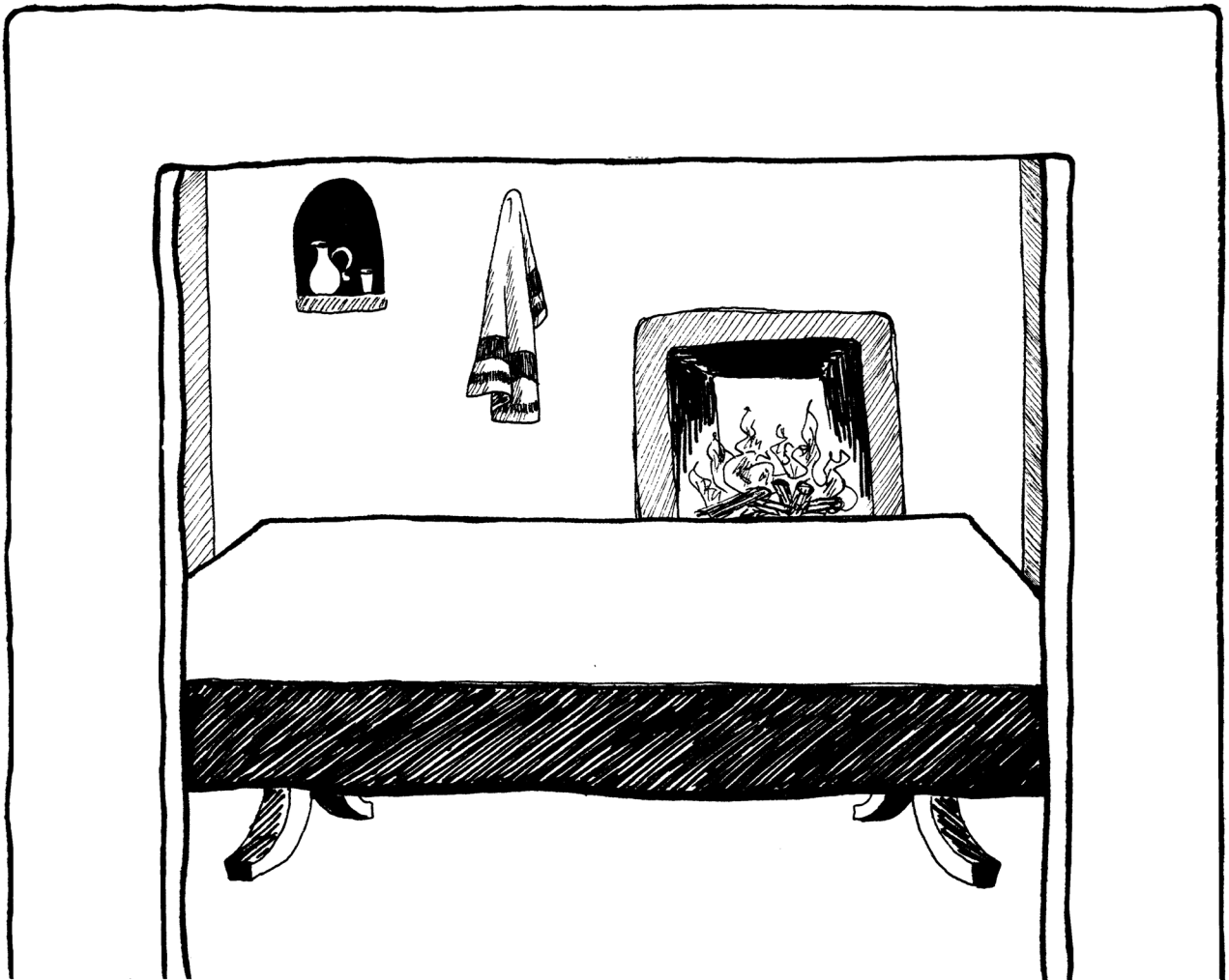

ACTIVITY SHEET 7: Living the Ten Commandments

PICTURES WITH CLARE

Narrator: Clare and three of her friends are spending the morning together.

Clare: Let's go outside and draw pictures!

Narrator: Clare and her friends take some pencils and paper outside and sit down in the shade. Everyone decides to draw something they see outdoors. After a few moments Clare says,

Clare: This is no good!

Narrator: She crumples her paper and tosses it away.

Brendan: I don't like mine either!

Narrator: Brendan throws his paper aside, too. Meg laughs and does the same.

Meg: Let's go for a walk instead!

Narrator: All the friends except Jonah walk away, leaving their papers behind. Jonah looks around. He gets up, collects all the papers, and puts them in the trash can. Then he joins his friends.

Jonah: Wait for me!

LYDIA'S A LITTLE LATE

Narrator: The Jensen family is up early on Sunday morning getting ready to leave for Mass. Mom is getting her coat on and Dad is getting his keys and glasses.

Alex: C'mon, Sophie, let's find your shoes! Lydia, what are you doing?

Lydia: I'm tired!

Narrator: Lydia is still in bed! Alex puts little Sophie's shoes on while she tugs at his hair.

Mom: Thanks, Alex! We better get in the van. Lydia, we're leaving!

Lydia: Can I just go tomorrow?

Dad: Turn off the lights, Alex!

Narrator: Alex runs back in the house to turn out all the lights. Lydia is racing around getting dressed and brushing her teeth. Alex gets back in the car.

Dad: Where's Lydia?

Narrator: Lydia jumps into her seat at the last minute.

Lydia: Let's go!

ACTIVITY SHEET 7: Living the Ten Commandments

THE SCIENCE TEST

Narrator: Three siblings are having an afternoon snack. Mom is in the next room feeding the baby.

Charlie: I got every answer right on my science test today!

Bridget: Really? Wow!

Jude: I sure didn't. And I have to study again and retake the test.

Charlie: I'm glad I don't have to do that! I can help you study if you want.

Narrator: Jude sulks.

Bridget: Don't worry, I'm sure you'll do fine next time. Oh! Charlie, Mom said for you to walk the dog now.

Charlie: Ok.

Narrator: Charlie goes to find the leash and Bridget picks up a book and starts reading. Jude wanders over to his mom.

Jude: Mom, Charlie said he's smarter than me because he got all the answers right on his science test! He said I'll never be as smart as he is.

Mom: Really? I'll have to talk to Charlie about that! And I'm sure you'll do fine if you spend more time studying before you take the test again.

Narrator: Jude wanders off as Bridget watches. After thinking for a moment Bridget gets up and goes to Mom.

Bridget: Mom, Charlie didn't say that. He was happy he did well on the test, that's all. And he said he would help Jude study.

Mom: Oh! Thanks for letting me know what really happened, Bridget. I'm glad to know Charlie didn't do something wrong.

ACTIVITY SHEET 8: Eve and Mary

Name: _____

Eve

Created without
Original Sin



Mary

Created without
Original Sin



ACTIVITY SHEET 9: The Last Supper

Name: _____

Color this picture of the Last Supper.

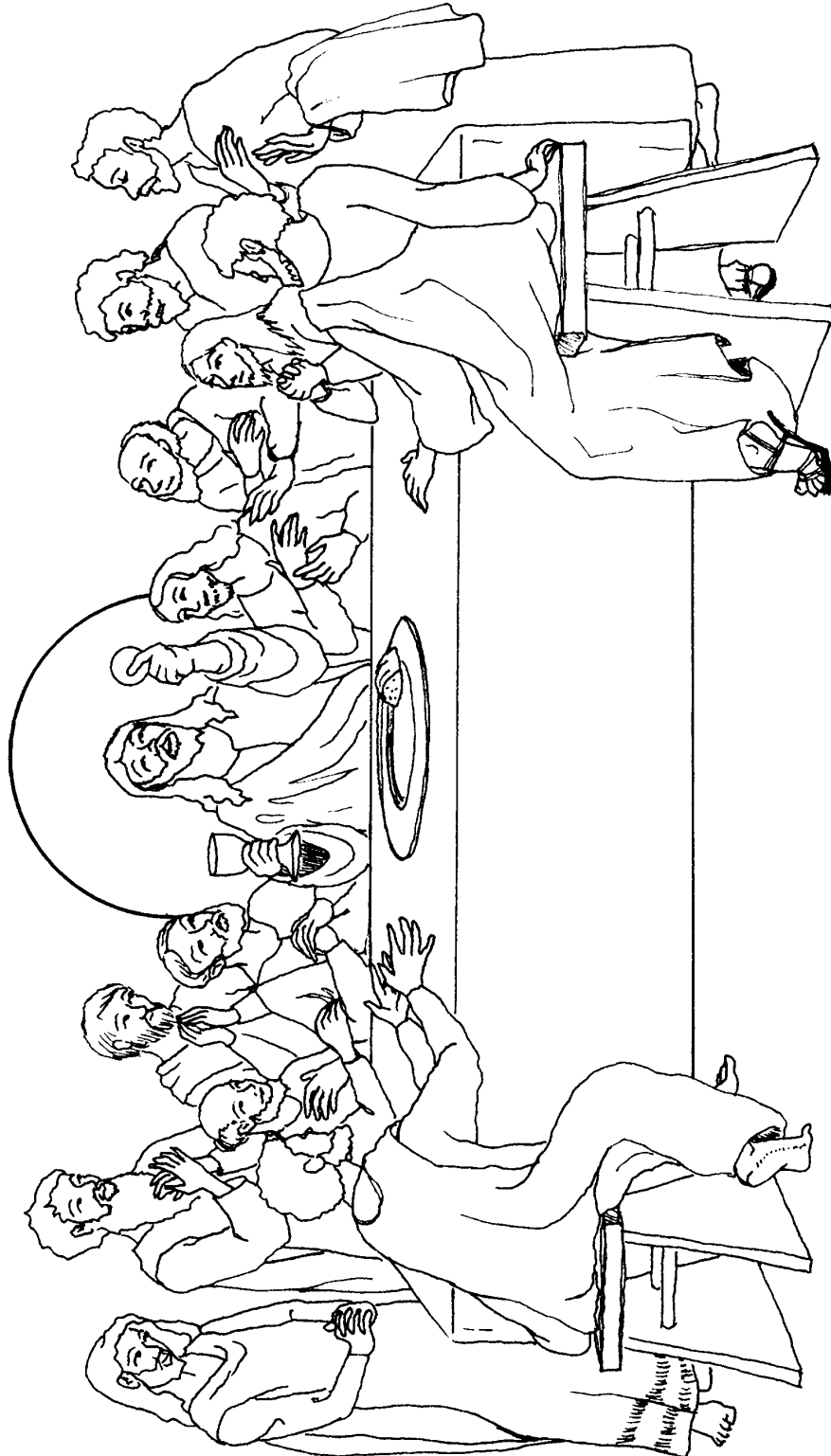

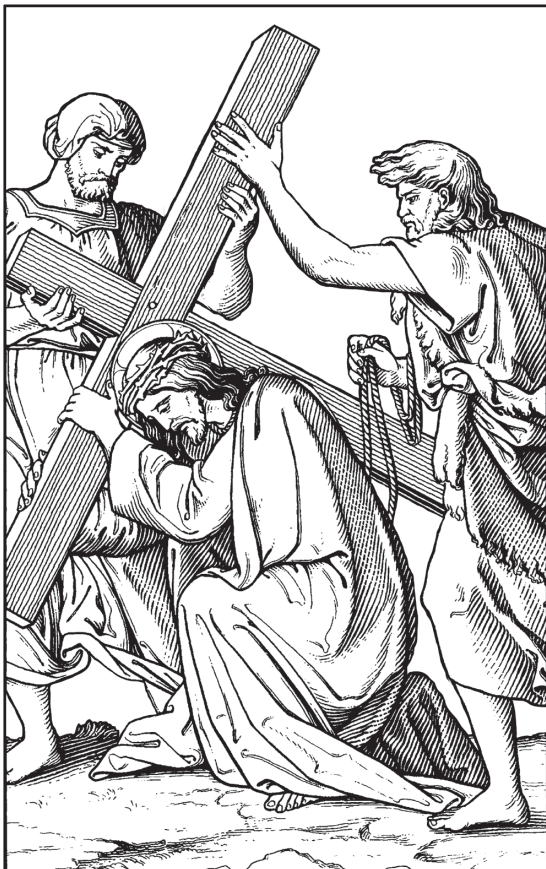
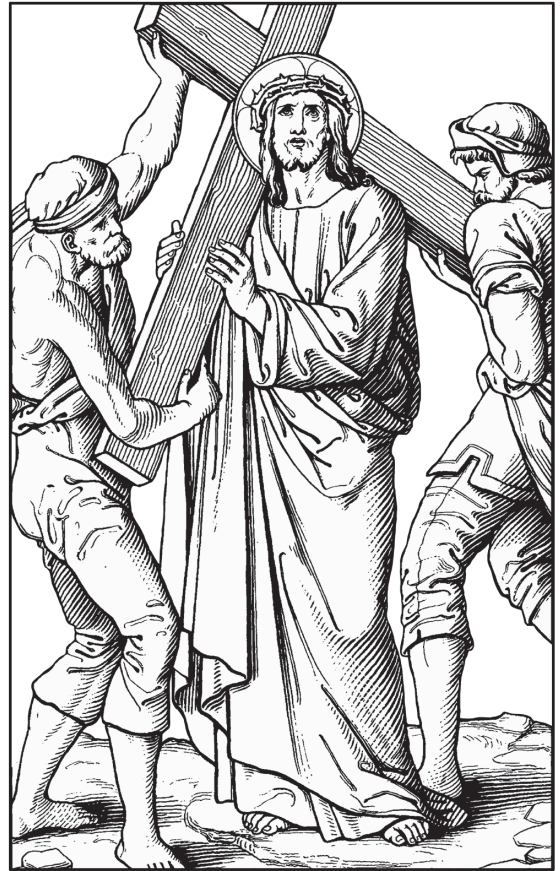

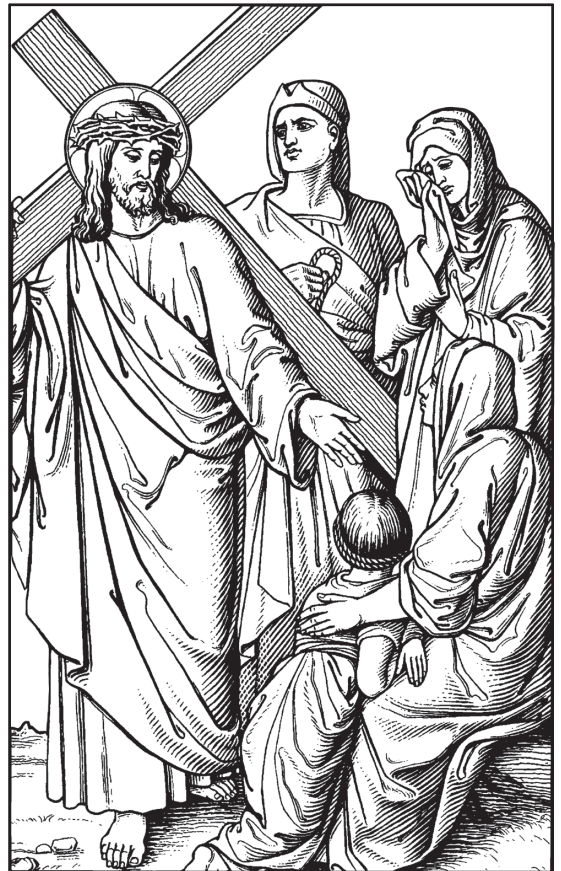

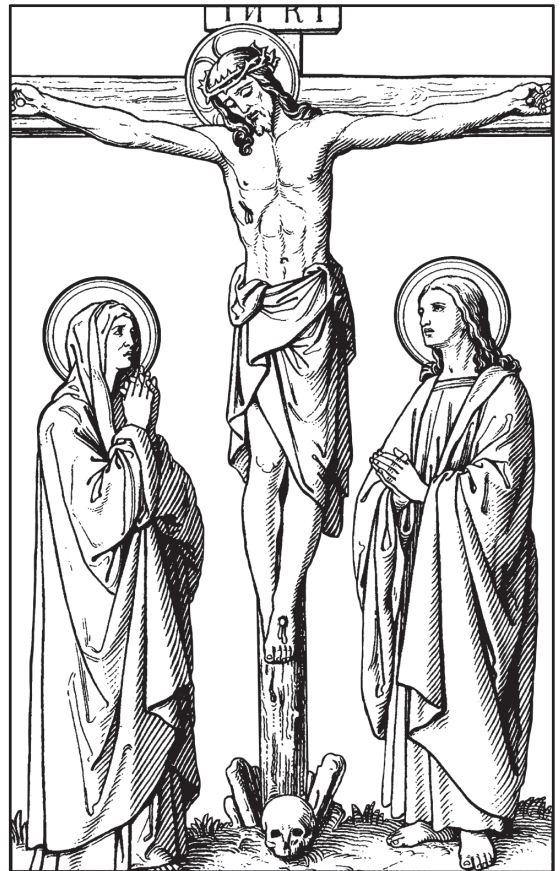
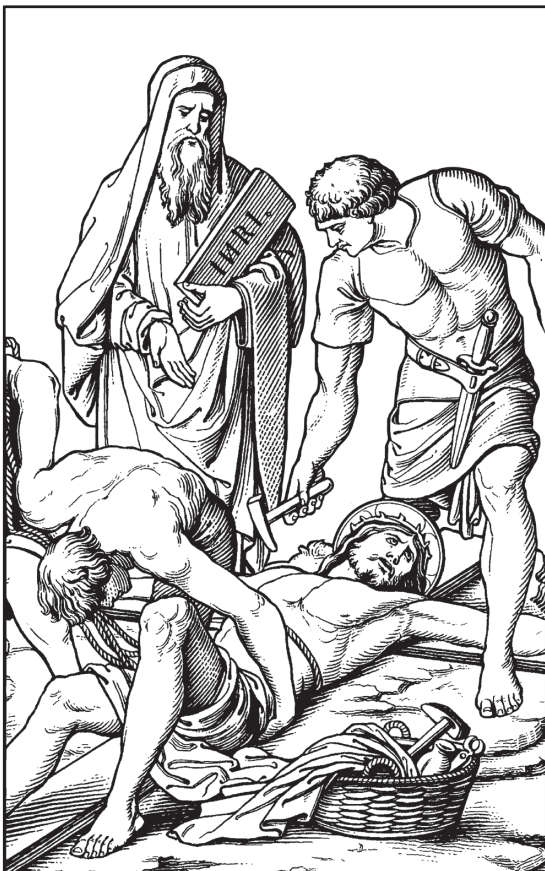
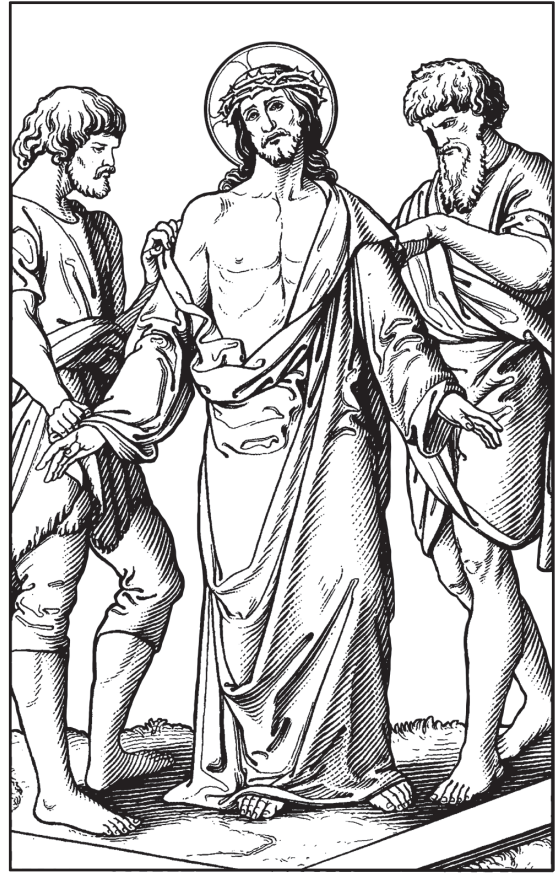
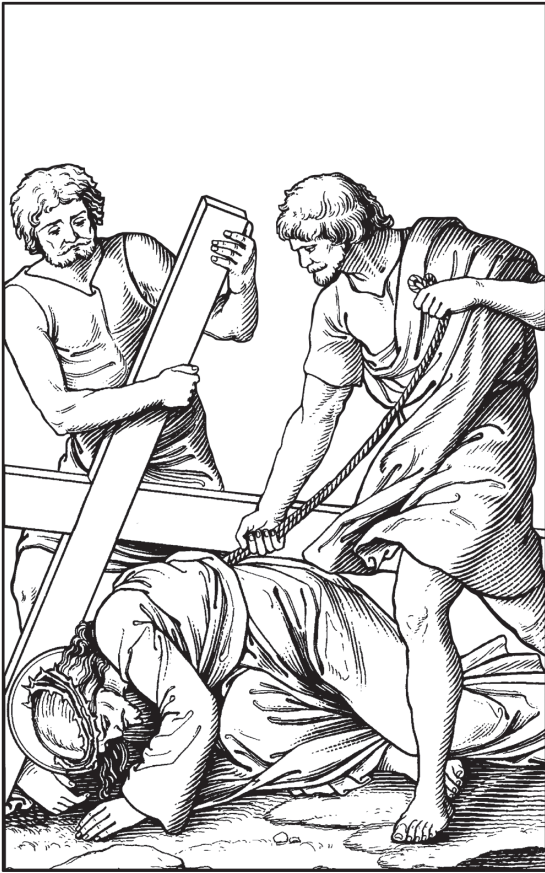

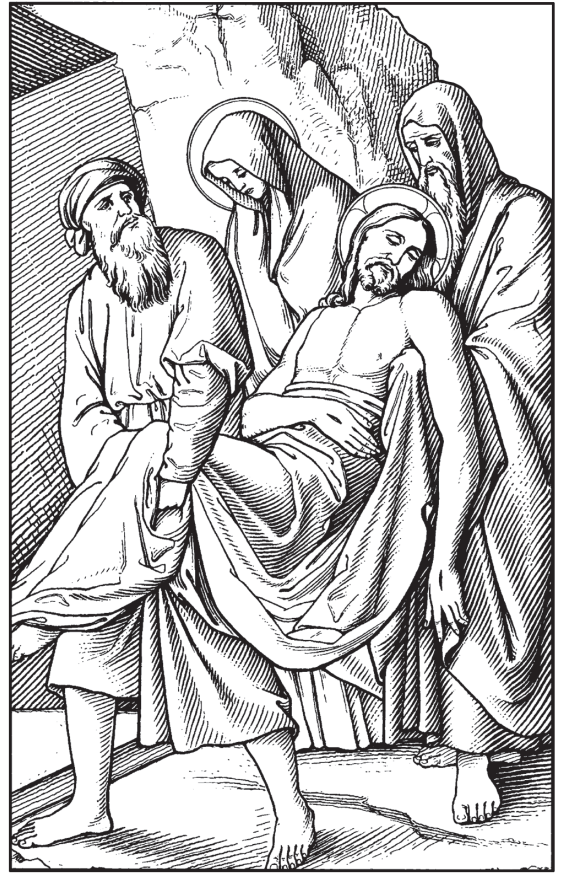

ACTIVITY SHEET 11A: Resurrection Cut-outs

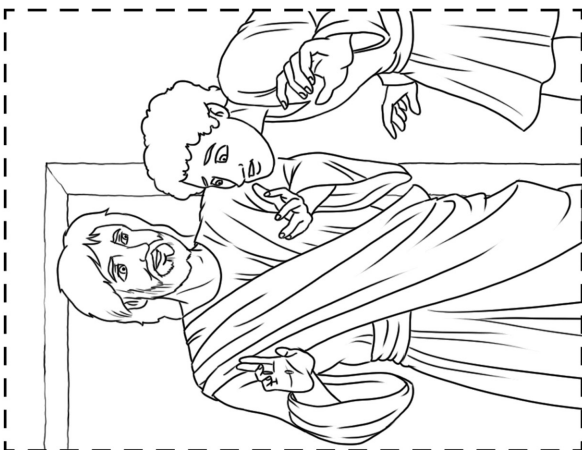
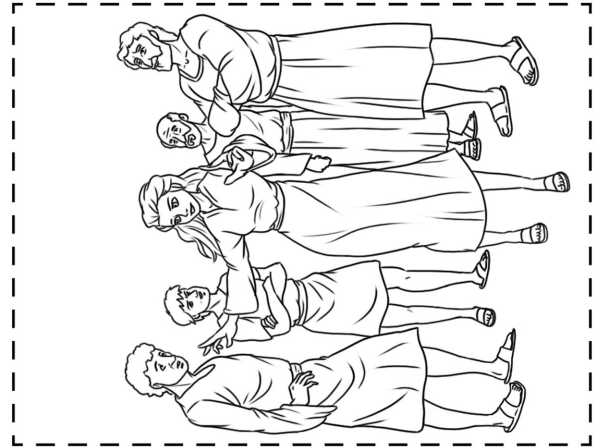

ACTIVITY SHEET 11B: **Christ Is Risen!**

Name: _____

At sundown on Good Friday,

Very early on Easter morning,

--	--	--

Jesus was buried.

He rose again! He was alive!

He appeared to Mary
Magdalene.

She told the Apostles.

Peter and John ran to the tomb.

Thomas doubted at first,

--	--	--

It was empty!

but when he saw Jesus
he believed.

ACTIVITY SHEET 12:
The Holy Spirit Helps Us Say “Yes” to God.

Name: _____

Answer the questions “yes” or “no.”

1. When Christ ascended into heaven, did he promise to send us a gift? _____
2. Is God in heaven while we are alone without him on earth? _____
3. Did God send us the Holy Spirit on the day of the Ascension? _____
4. Is Pentecost the birthday of the Church? _____
5. Does the Holy Spirit live in our hearts and help us pray? _____
6. Is the Holy Spirit a “force” like gravity or electricity? _____
7. Is the Holy Spirit God? _____

ACTIVITY SHEET 13: Apostolic Succession

Name: _____

Fill in the first three blanks with names.





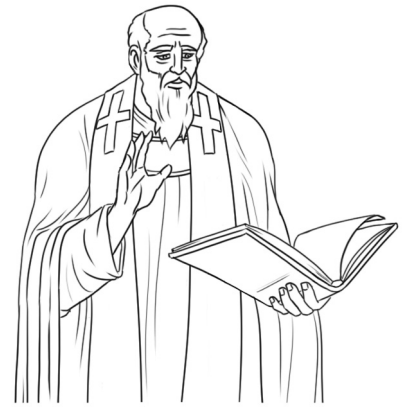

Fill in the blanks to complete the sentences.

_____ chose Twelve _____. The Apostles chose _____
to replace them. Those bishops chose other _____. This continued all
over the world, down to our own time.

ACTIVITY SHEET 14A: Sacramental Cut-outs

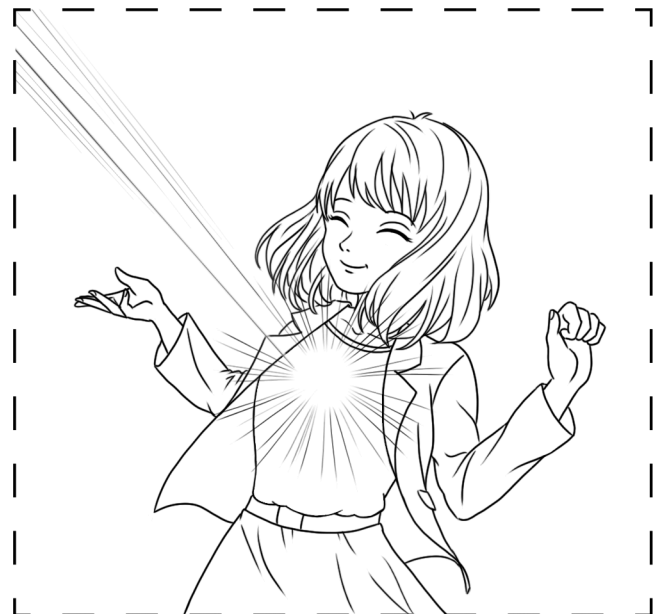
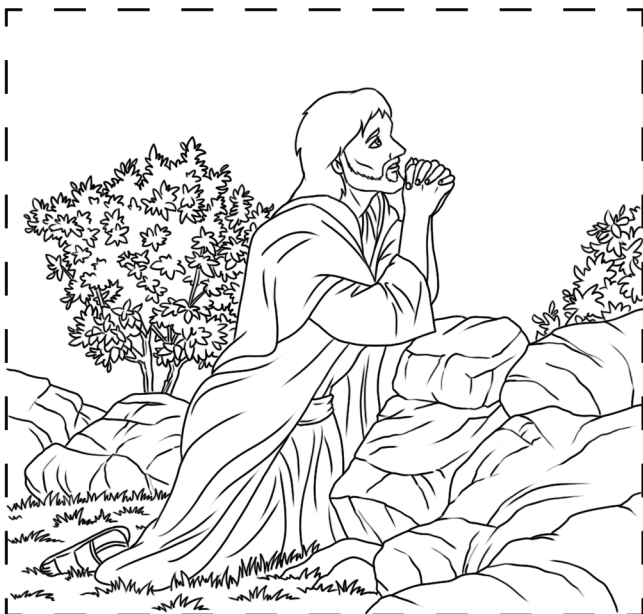
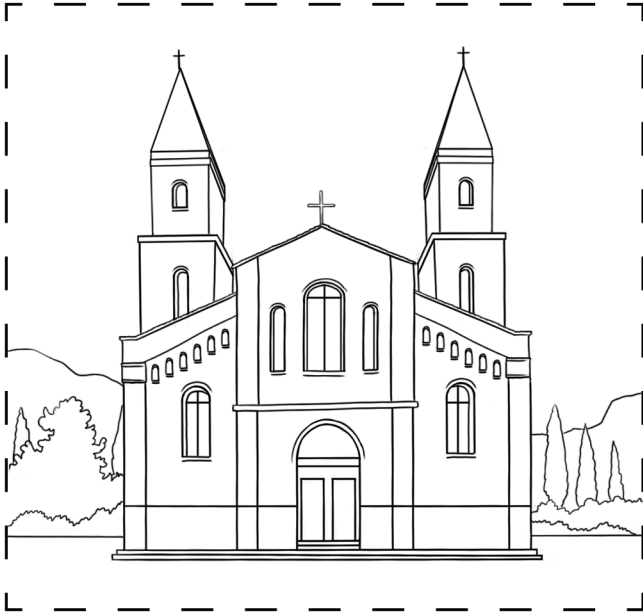

ACTIVITY SHEET 14B:
What is a Sacrament?

Name: _____

Glue your picture to each box, and fill in the blank below each box.

A Sacrament is an outward

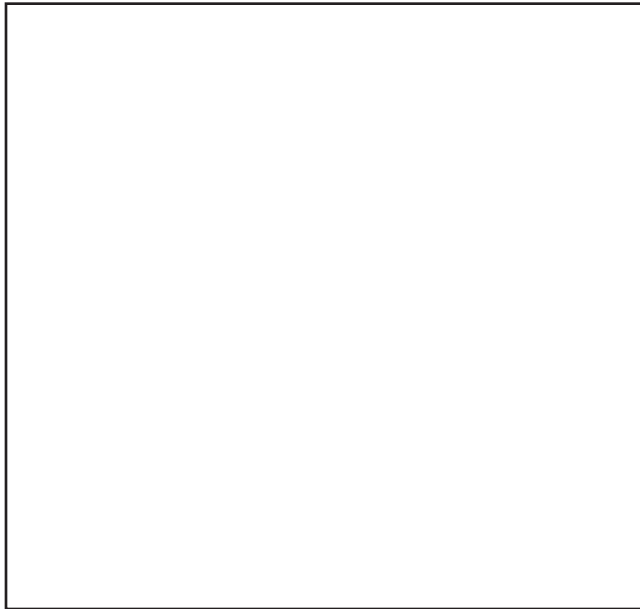

instituted by

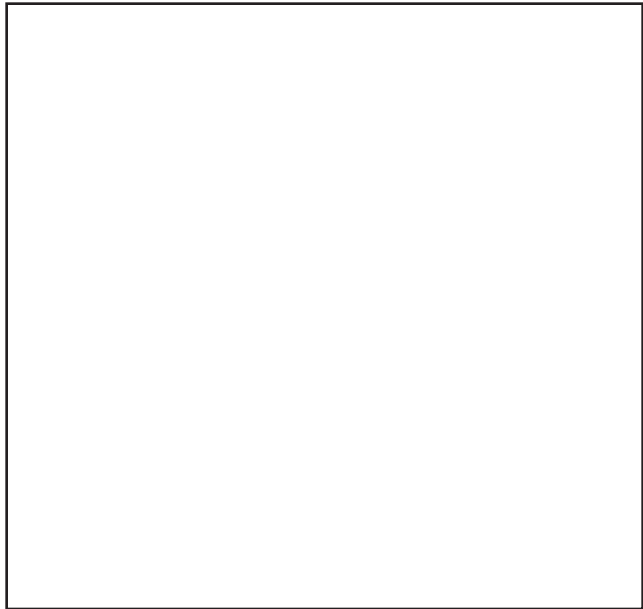

and entrusted to the

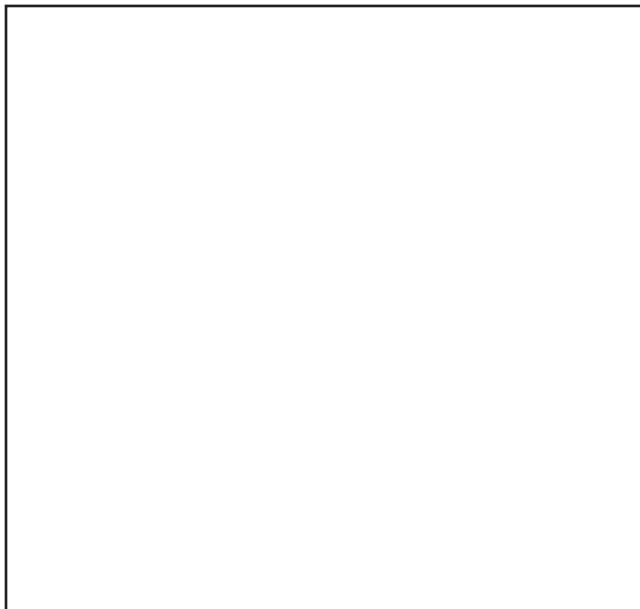

to give

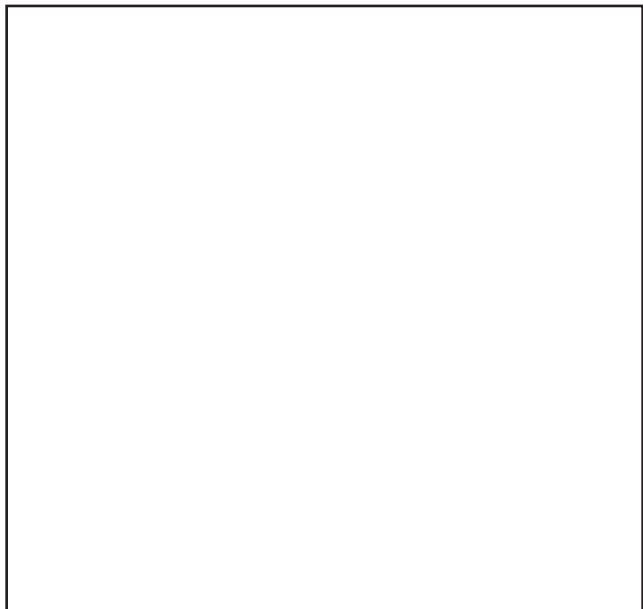

ACTIVITY SHEET 15: Doorway to God's Family

Name: _____

Circle the correct word or phrase to tell what happened when you were baptized.



1. The first Sacrament I received was _____ .
Penance
Baptism
2. My _____ made promises for me, that I would follow Jesus and reject Satan.
Godparents
Pastor
3. I was baptized in the name of _____ .
My parents
The Father, Son, and Holy Spirit
4. The priest or deacon poured _____ on my head three times.
Oil
Water
5. Because I have been _____, I can receive the other Sacraments.
Baptized
Confirmed
6. Through my Baptism I became a _____ of God.
Fan
Child

ACTIVITY SHEET 16:
Sin or Grace

Name: _____

Fill in each blank with "Sin" or "Grace."

_____ is God's life in us.

_____ can take away God's life from us.

_____ can be received in the Sacraments.

_____ is like making our soul sick or killing it.

_____ can be forgiven in the Sacrament of Penance.

_____ is God's gift to us to help us reach heaven.

ACTIVITY SHEET 17: How to Make a Good Confession: Matching

Name: _____

Draw a line to match each step in making a good Confession with the item that explains the step. Then place the letter for each answer above the number of its match to answer the question.

- | | |
|---------------------------|---|
| 1. Examine my conscience. | R — Be sorry for my sins. |
| 2. Contrition. | A — Tell my sins to a priest. |
| 3. Confess. | E — Make changes to help me avoid sin. |
| 4. Complete my penance. | C — Do the penance the priest gives me. |
| 5. Change. | G — Think about what I did wrong. |

What is God's life in our soul?

1

2

3

4

5

ACTIVITY SHEET 18: Practice for the Sacrament of Penance

Name: _____

Priest: In the name of the Father and of the Son and of the Holy Spirit.

Penitent: Bless me, Father, for I have sinned. It has been _____ (how long) since my last confession. I accuse myself of the following sins.

Penitent: [State your (pretend) sins.]

Priest: For your penance, _____
(Tell the penitent what to do for a penance).

Penitent: (Say an *Act of Contrition*.)

O my God, I am sorry for my sins with all my heart.
In choosing to do wrong, and failing to do good,
I have sinned against you, whom I should love above all things.
I firmly intend, with the help of your grace,
to do penance, to sin no more, and to avoid whatever leads me to sin.
Our Savior Jesus Christ suffered and died for us.
In his name, my God, have mercy.

Priest: ... I absolve you from your sins in the name of the Father, and of the Son, and of the Holy Spirit. God has freed you from your sins. Go in peace.

Penitent: Thanks be to God. Thank you, Father.

ACTIVITY SHEET 19:
Jesus Celebrates the Passover Meal with His Apostles.

Name: _____

Draw a picture of the Last Supper.

At the Last Supper, Jesus changed the bread and wine into his Body and Blood.

ACTIVITY SHEET 20: The Holy Sacrifice of the Mass

Name: _____

Memorial

We participate in Christ's saving work.

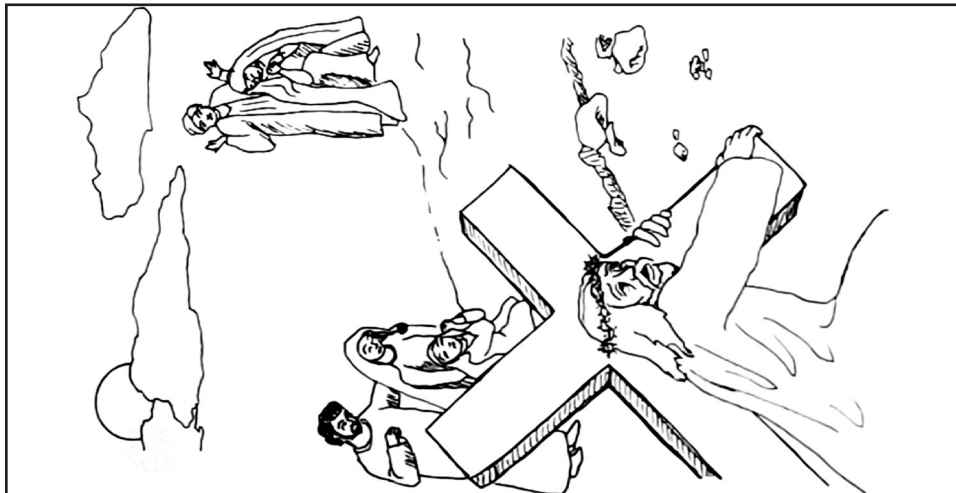

Sacrifice

The Sacrifice of the Mass is the same Sacrifice as that of Jesus on the Cross.

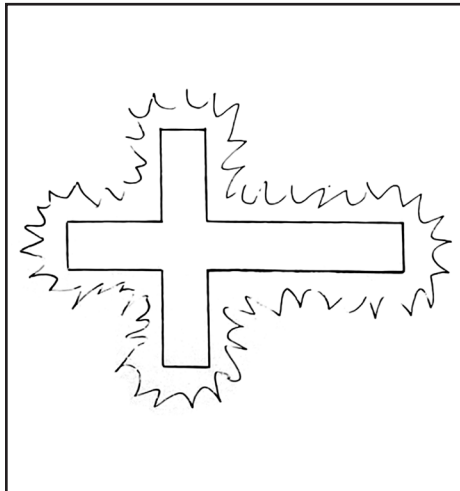

Worship

The Mass is the perfect way to worship God.

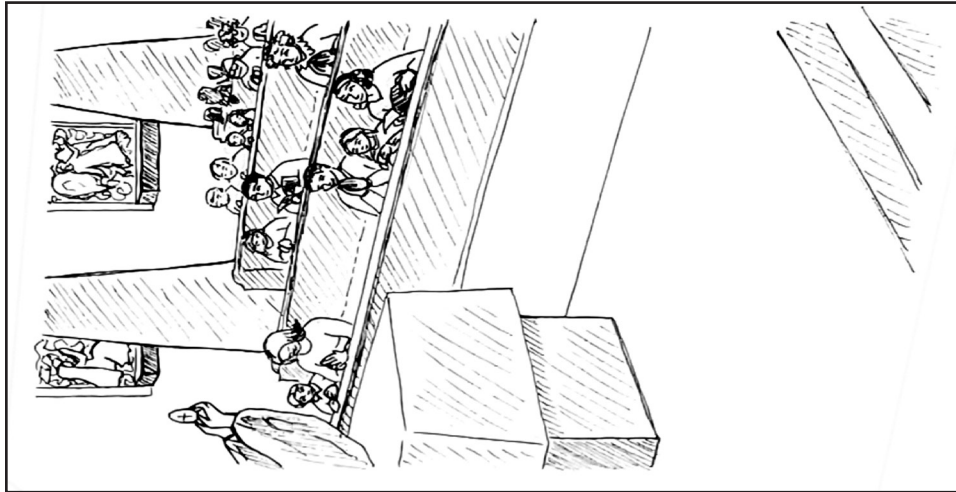

ACTIVITY SHEET 21:
A Monstrance

Name: _____

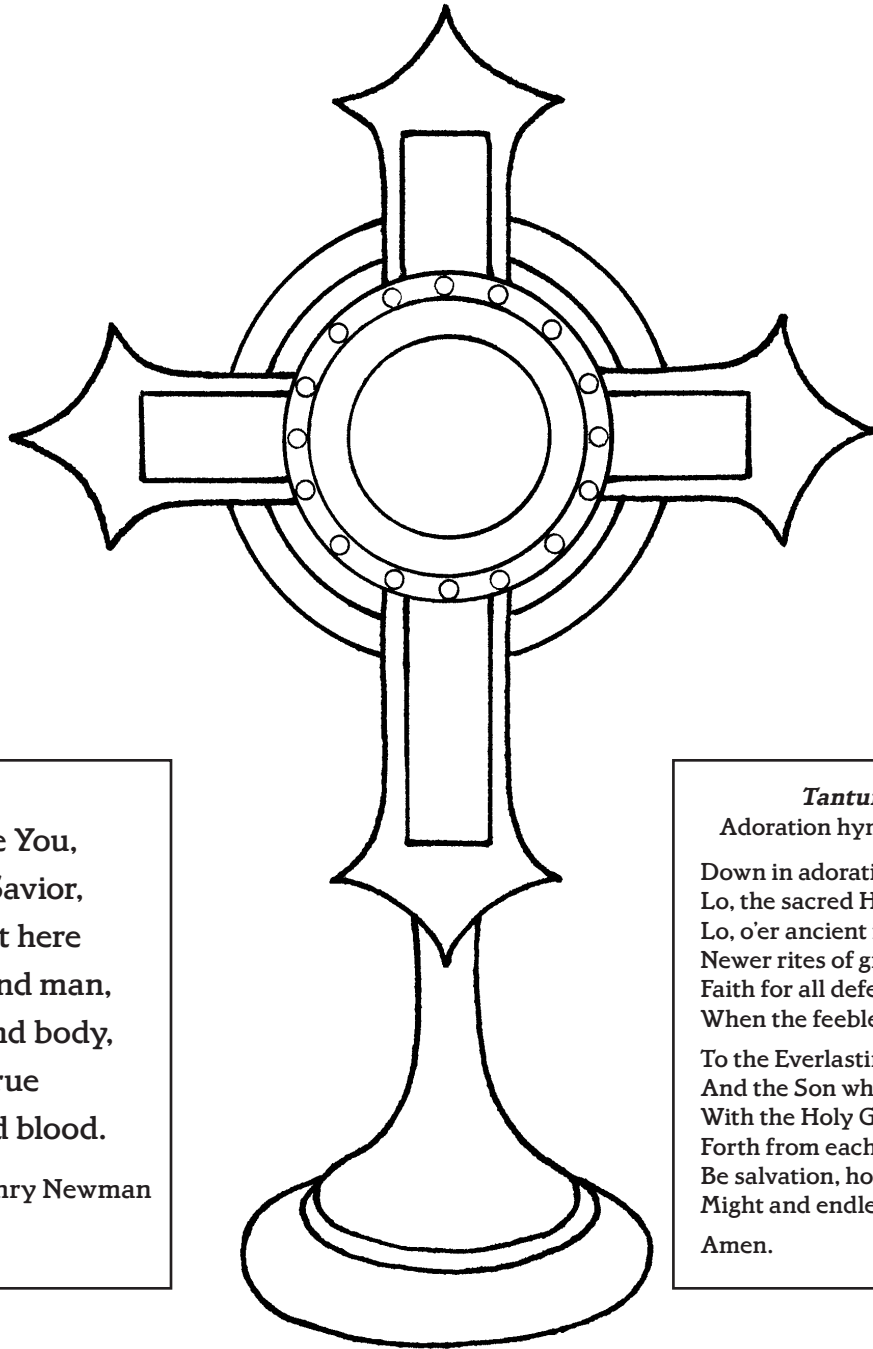

I adore You,
O my Savior,
present here
as God and man,
in soul and body,
in true
flesh and blood.

—Bl. John Henry Newman

Tantum Ergo

Adoration hymn (in English)

Down in adoration falling,
Lo, the sacred Host we hail,
Lo, o'er ancient forms departing
Newer rites of grace prevail:
Faith for all defects supplying,
When the feeble senses fail.

To the Everlasting Father
And the Son who comes on high
With the Holy Ghost proceeding
Forth from each eternally,
Be salvation, honor, blessing,
Might and endless majesty.
Amen.

ACTIVITY SHEET 22: Preparing to Receive Jesus

Name: _____

Prepare Your Heart

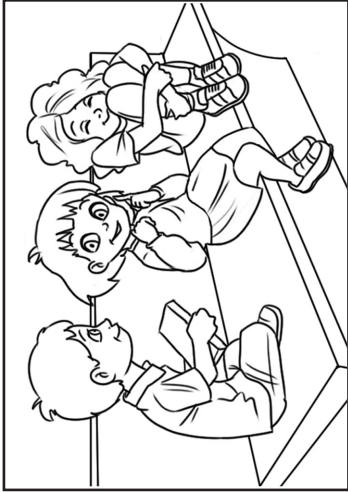

Prepare Your Soul

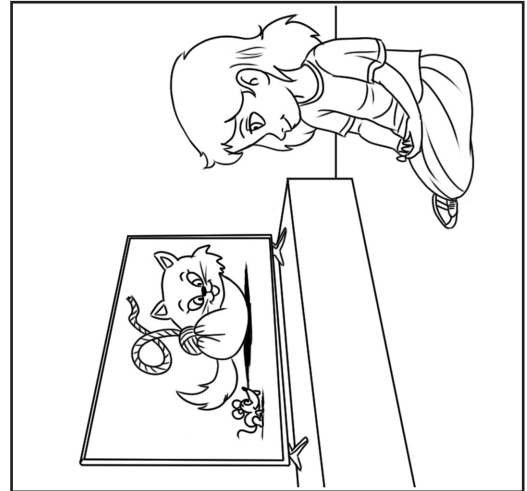
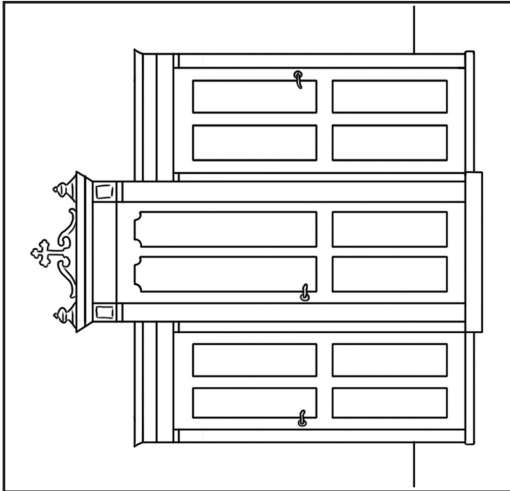

Prepare Your Body

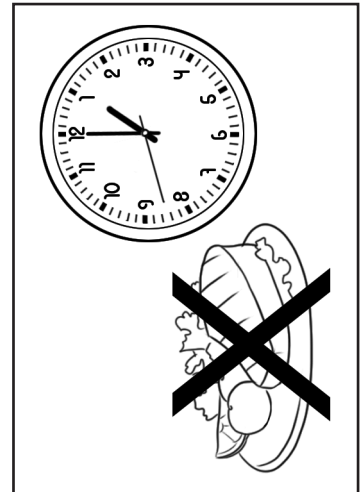
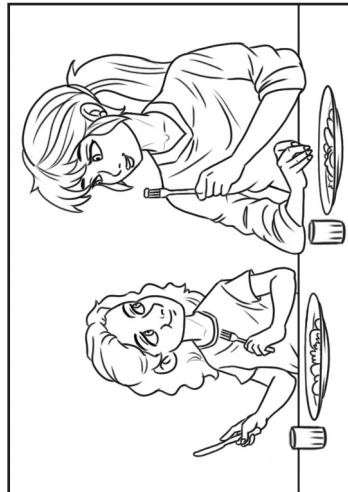
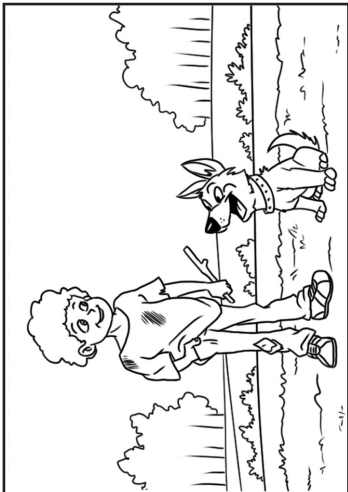

ACTIVITY SHEET 23A: Sacred Vessels

CHALICE

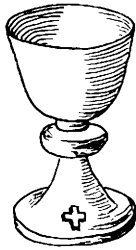

PATEN



PURIFICATOR

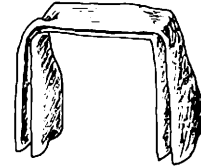

CIBORIUM



CRUCIFIX



HOST



CANDLE

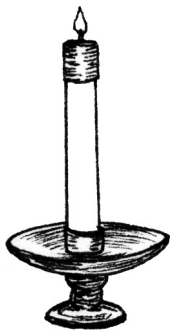

CORPORAL

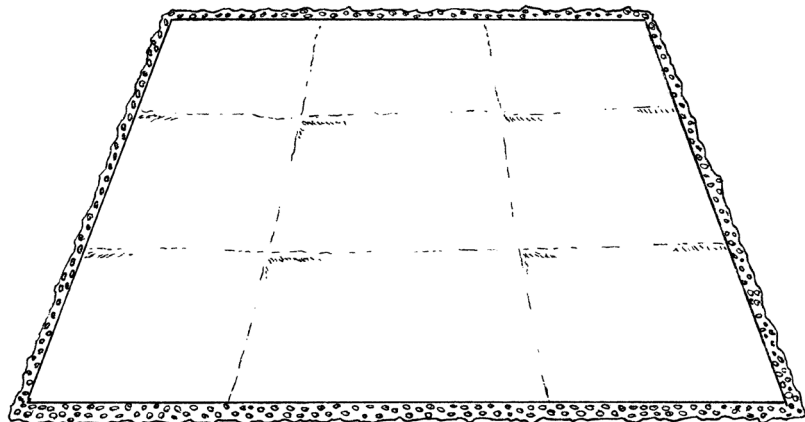

ACTIVITY SHEET 23B: The Sacred Vessels

Name: _____

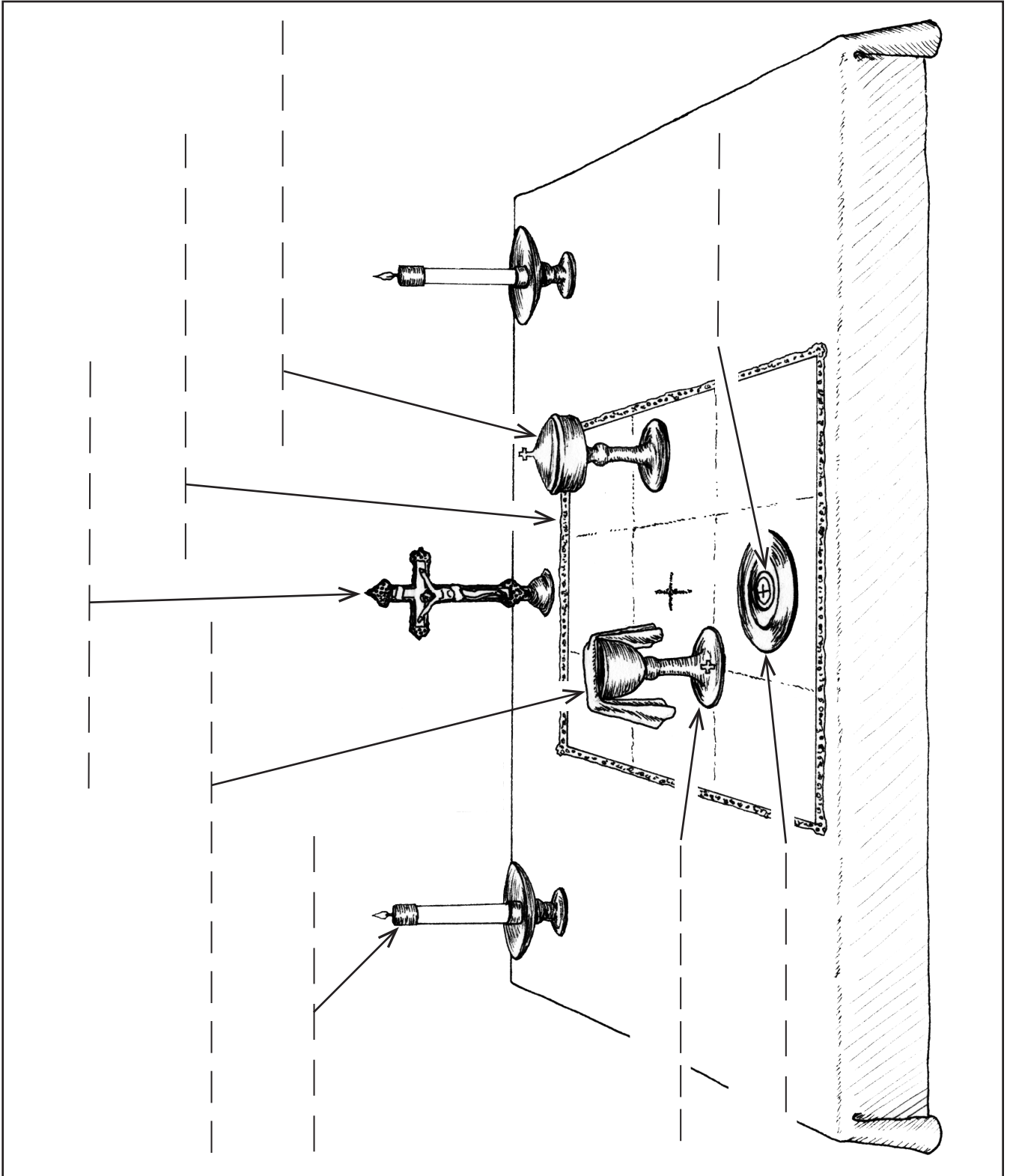

ACTIVITY SHEET 24:
Stay with Me, Jesus.

With Jesus in my heart through the gift of the Eucharist,
I become a walking tabernacle.
Stay with me, Jesus, forever and ever.

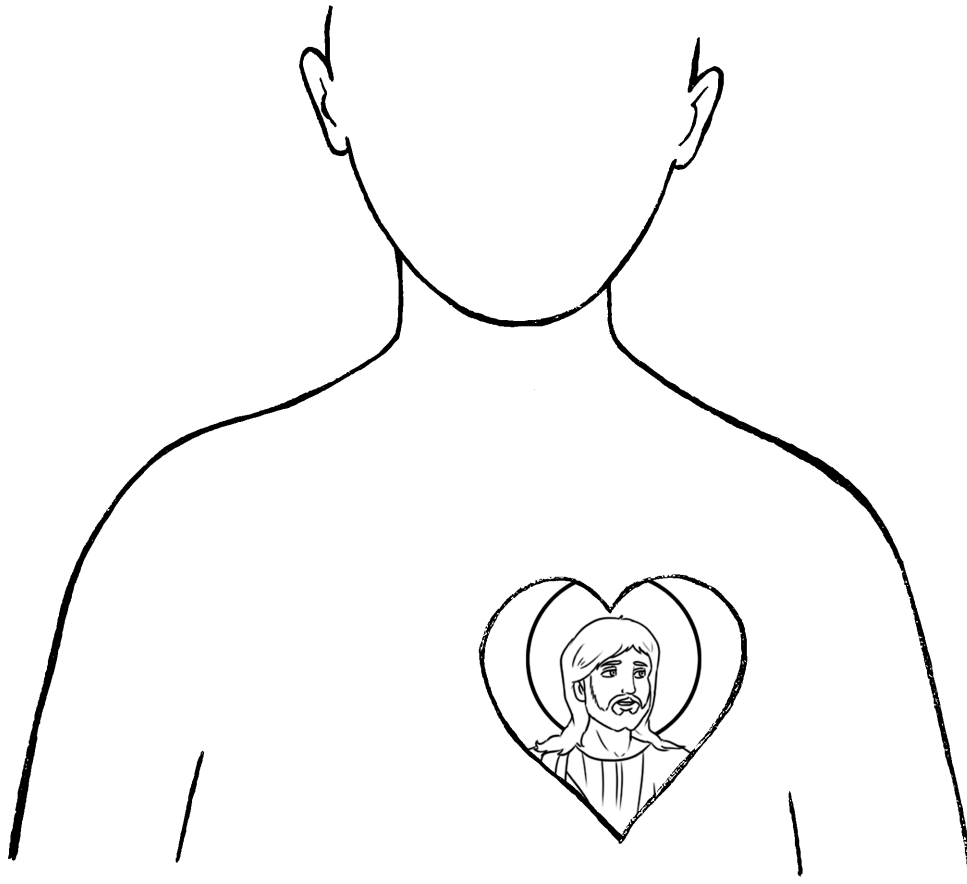

Your Name